

Multiway®

■ SINCE 1978 ■

HOSPITAL GRADE POWER EXTENSION CORDS



For enquiry, please send email :
Sales@Multiway.com



Multiway Ind.(HK)Ltd.(Taiwan Office)

5F.,No.87, Aly.3, Ln.182, Sec.2, Wenhua Rd., Banqiao Dist.,
New Taipei City 220, Taiwan
TEL:886-2-8258-1969 FAX:886-2-8258-1959
E-mail:sales@multiway.com Web site:www.multiway.com

Multiway Electrical Ind.(Shenzhen)CO.Ltd.

UNIT 1910, 19/F,XINHUA INSURANCE BLDG #171 MINTIAN ROAD, CBD,
FUTIAN DISTRICT, SHENZHEN, GUANGDONG 518026, CHINA
TEL:86-755-8826-6328 FAX:86-755-8826-6308
E-mail:sales@multiway.com Web site:www.multiway.com

Multiway Electrical Ind.(Shenzhen)CO.Ltd.(Factory)

NO.609, JINBI ROAD, BILING VILLAGE, PINGSHAN TOWN, LONGGANG DISTRICT SHENZHEN,
GUANGDONG 518118, CHINA
TEL:86-755-8993-0108 FAX:86-755-8993-1007
E-mail:sales@multiway.com Web site:www.multiway.com

Hospital Grade cord set

FW-0281-0819-SEE CHART



028-1 PLUG

819

- ★ Hospital Grade Cord set - SJT Cable with C13 to 5-15P, Plug, 18/3 AWG, 10A

- ★ Hospital Grade Cord set - SJT Cable with C13 to 5-15P, Plug, clear plug, 16/3 AWG, 13A

- ★ Hospital Grade Cord set - SJT Cable with C13 to 5-15P, Plug, 14/3 AWG, 15A



clear plug

Hospital Grade cord set

FW-0281-0819-SEE CHART

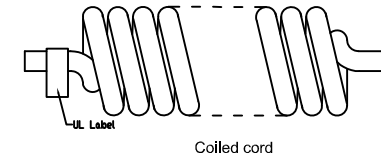
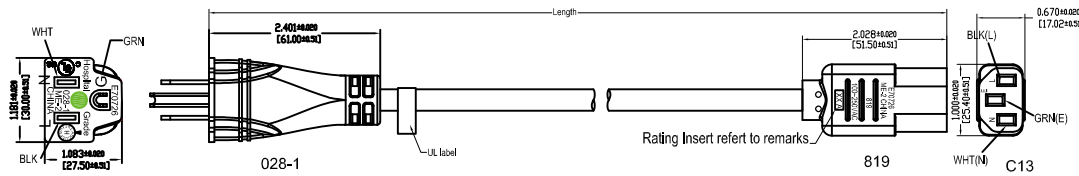

Part No.	Length	Type of Cable	Color of Cable	Color of Male	Color of Female	Remarks
-001	3' ± 1.5"	SJT 18/3 60°C	Black	Black	Black	10A
-002	6' ± 2"	SJT 18/3 60°C	Black	Black	Black	10A
-003	10' ± 2"	SJT 18/3 60°C	Black	Black	Black	10A
-004	15' ± 2"	SJT 18/3 60°C	Black	Black	Black	10A
-005	3' ± 1.5"	SJT 16/3 60°C	Black	Black	Black	13A
-006	6' ± 2"	SJT 16/3 60°C	Black	Black	Black	13A
-007	10' ± 2"	SJT 16/3 60°C	Black	Black	Black	13A
-008	15' ± 2"	SJT 16/3 60°C	Black	Black	Black	13A
-009	25' ± 2"	SJT 14/3 60°C	Black	Black	Black	15A
-010	8' ± 2"	SJT 18/3 60°C Coiled cord	Black	Black	Black	10A

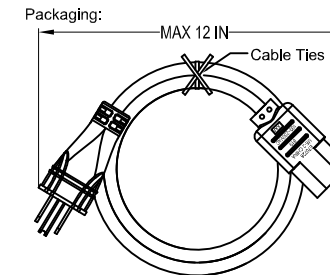
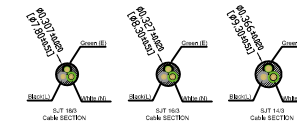

Notes:

1. Products are UL/cUL approved in NEMA WD-6 & IEC configurations under file E70726.
2. Connector have no IEC or any European approval.
3. Multiway cable UL file number is E173957.
4. MM dimensions shown in brackets are for reference only.
5. ● Symbol for Hospital Grade extension cord.



Hospital Grade cord set FW-0918-0819-SEE CHART

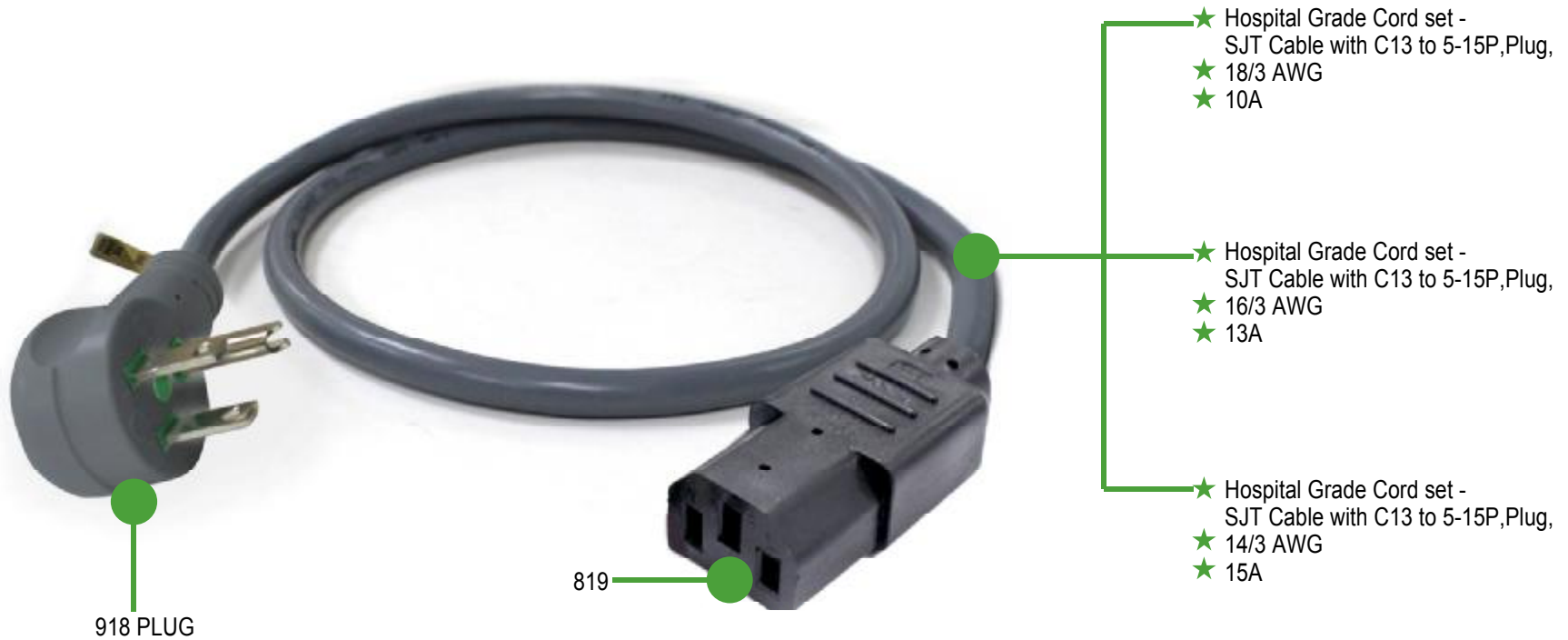

Hospital Grade cord set

FW-0918-0819-SEE CHART

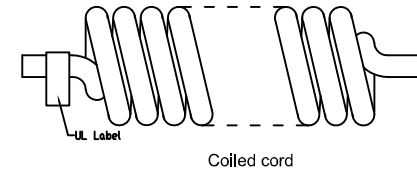
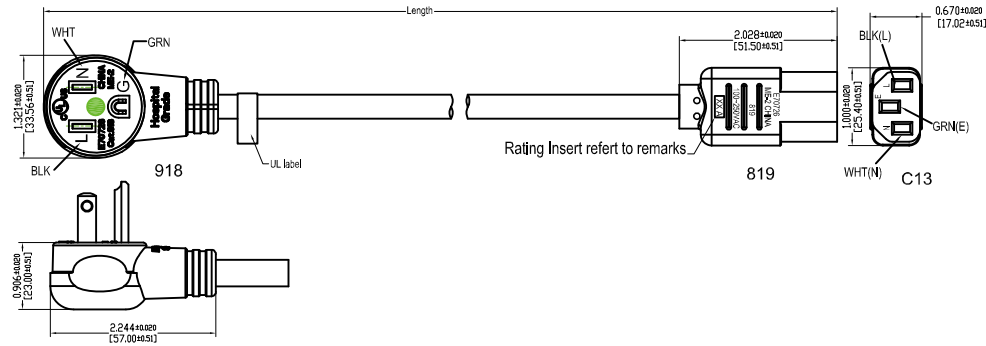

Part No.	Length	Type of Cable	Color of Cable	Color of Male	Color of Female	Remarks
-001	3' ± 1.5"	SJT 18/3 60° C	Black	Black	Black	10A
-002	6' ± 2"	SJT 18/3 60° C	Black	Black	Black	10A
-003	10' ± 2"	SJT 18/3 60° C	Black	Black	Black	10A
-004	15' ± 2"	SJT 18/3 60° C	Black	Black	Black	10A
-005	3' ± 1.5"	SJT 16/3 60° C	Black	Black	Black	13A
-006	6' ± 2"	SJT 16/3 60° C	Black	Black	Black	13A
-007	10' ± 2"	SJT 16/3 60° C	Black	Black	Black	13A
-008	15' ± 2"	SJT 16/3 60° C	Black	Black	Black	13A
-009	25' ± 2"	SJT 14/3 60° C	Black	Black	Black	15A
-010	8' ± 2"	SJT 18/3 60° C Coiled cord	Black	Black	Black	10A

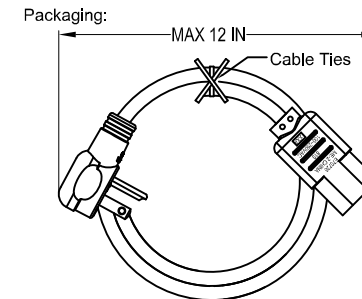
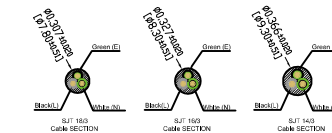

Notes:

1. Products are UL/cUL approved in NEMA WD-6 & IEC configurations under file E70726.
2. Connector have no IEC or any European approval.
3. Multiway cable UL file number is E173957.
4. MM dimensions shown in brackets are for reference only.
5. ● Symbol for Hospital Grade extension cord.



Hospital Grade Extension Cord FW-0281-PF9SH-SEE CHART

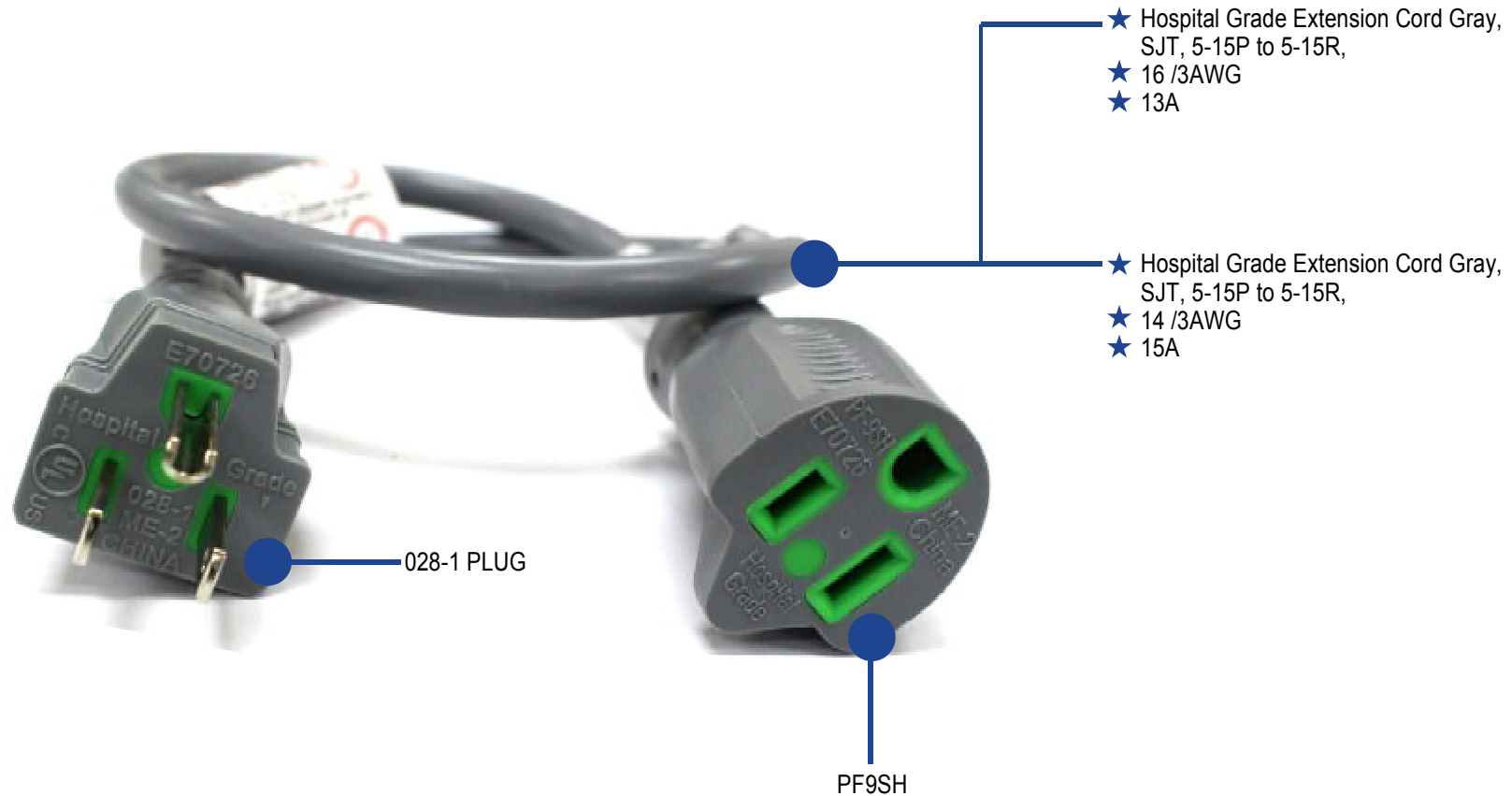

Hospital Grade Extension Cord FW-0281-PF9SH-SEE CHART

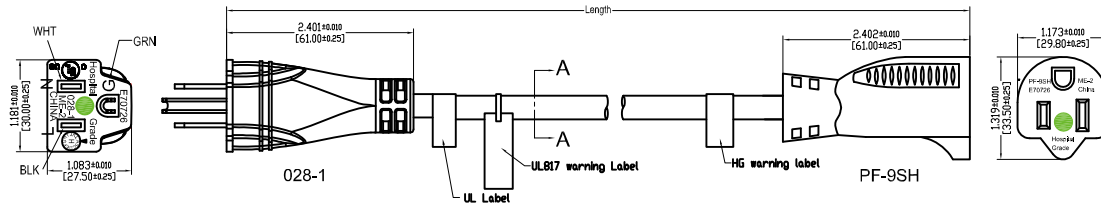

Part No.	Length	Type of Cable	Color of Cable	Color of Male	Color of Female	Remarks
-001	2' ± 1"	SJT 16/3 60°C	Gray	Gray	Gray	13A
-002	6' ± 2"	SJT 16/3 60°C	Gray	Gray	Gray	13A
-003	15' ± 2"	SJT 16/3 60°C	Gray	Gray	Gray	13A
-004	6' ± 2"	SJT 14/3 60°C	Gray	Gray	Gray	15A
-005	15' ± 2"	SJT 14/3 60°C	Gray	Gray	Gray	15A

Notes:

1. Products are UL/cUL approved in NEMA WD-6 configurations under file E70726.
2. Multiway cable UL file number is E173957.
3. MM dimensions shown in brackets are for reference only.
4. Hospital grade extension cord set shall have a maximum length of 4.6 m (15 ft). Per UL817 section 10.12.23.
5. ● Symbol for Hospital Grade extension cord.

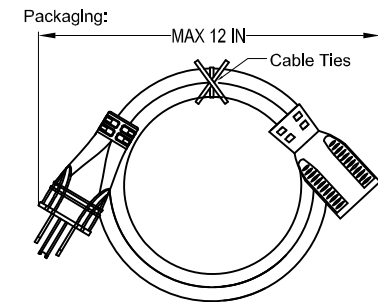
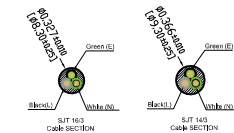

Hospital Grade Extension Cord FW-0918-PF9SH-SEE CHART

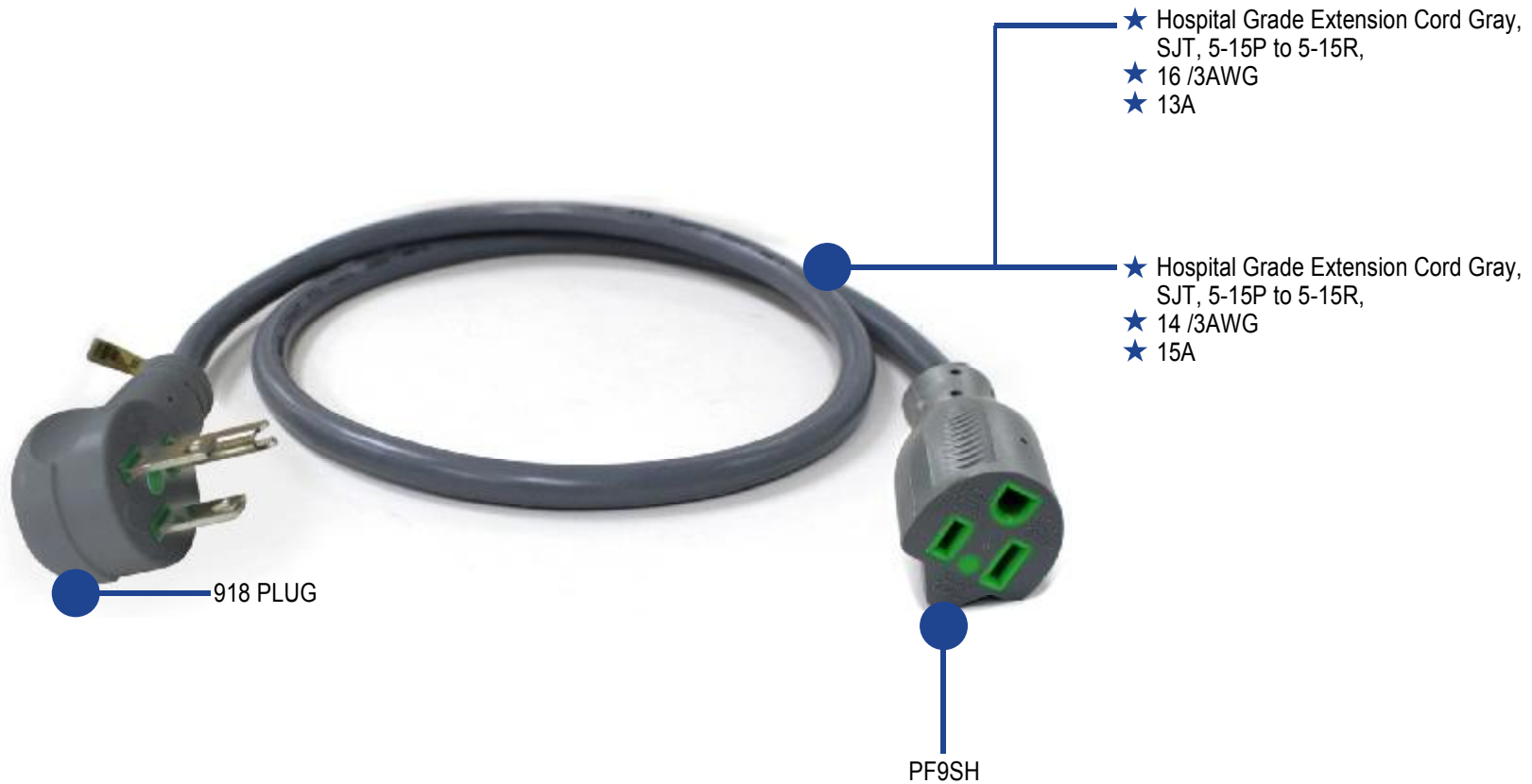

Hospital Grade Extension Cord FW-0918-PF9SH-SEE CHART

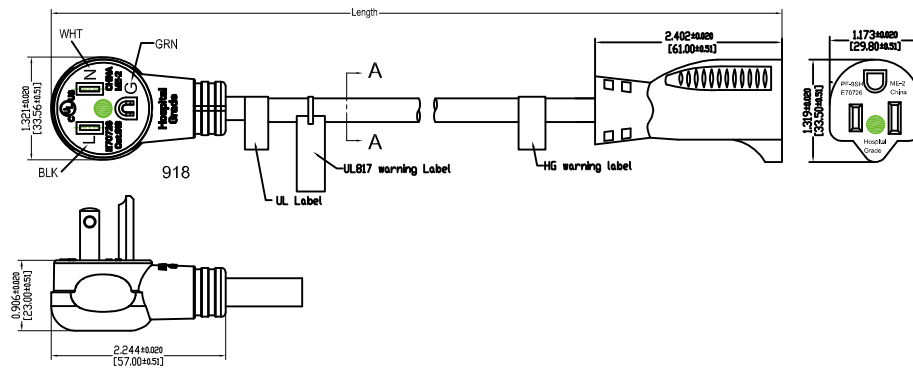

Part No.	Length	Type of Cable	Color of Cable	Color of Male	Color of Female	Remarks
-001	2' ± 1"	SJT 16/3 60°C	Gray	Gray	Gray	13A
-002	6' ± 2"	SJT 16/3 60°C	Gray	Gray	Gray	13A
-003	15' ± 2"	SJT 16/3 60°C	Gray	Gray	Gray	13A
-004	6' ± 2"	SJT 14/3 60°C	Gray	Gray	Gray	15A
-005	15' ± 2"	SJT 14/3 60°C	Gray	Gray	Gray	15A

Notes:

1. Products are UL/cUL approved in NEMA WD-6 configurations under file E70726.
2. Multiway cable UL file number is E173957.
3. MM dimensions shown in brackets are for reference only.
4. Hospital grade extension cord set shall have a maximum length of 4.6 m (15 ft).
5. ● Symbol for Hospital Grade extension cord.

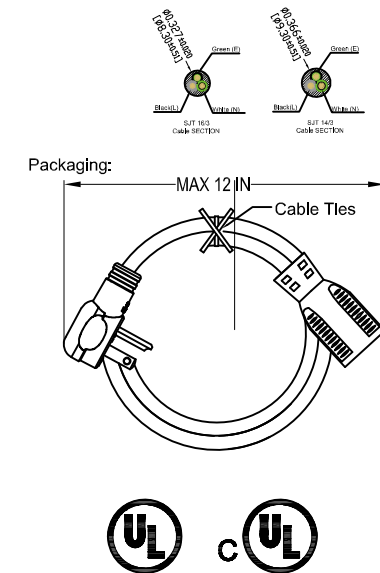

Hospital Grade Power Cord

FW-0281-SEE CHART

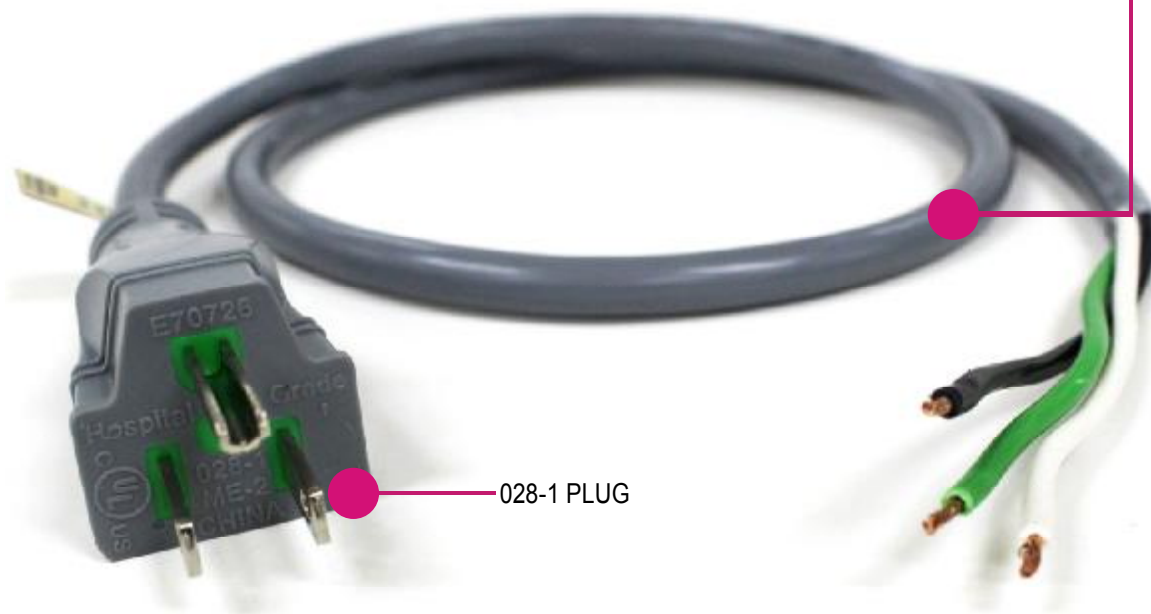

- ★ Hospital Grade Power Cord Gray, SJT, 5-15P to 5-15R,
- ★ 14/3AWG
- ★ 15A

028-1 PLUG

Hospital Grade Power Cord

FW-0281-SEE CHART

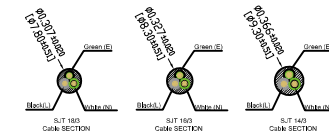
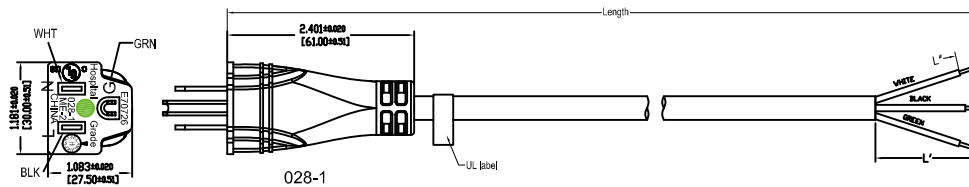

Part No.	Length	Type of Cable	Color of Cable	Color of Male	L' (Black)	L' (White)	L' (Green)	L" (Black)	L" (White)	L"(Green)	Remarks
-001	6.5' ± 1.5"	SJT 14/3 75°C	White	White	95mm	95mm	95mm	8mm	8mm	8mm	15A
-002	10.5' ± 2"	SJT 14/3 75°C	White	White	95mm	95mm	95mm	8mm	8mm	8mm	15A
-003	15.5' ± 2"	SJT 14/3 75°C	White	White	95mm	95mm	95mm	8mm	8mm	8mm	15A

Notes:

1. Products are UL/cUL approved in NEMA WD-6 configurations under file E70726.
2. Multiway cable UL file number is E173957.
3. MM dimensions shown in brackets are for reference only.
4. ● Symbol for Hospital Grade extension cord.

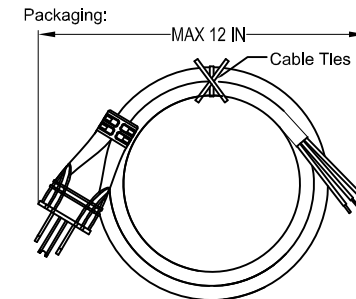

Hospital Grade Power Cord

FW-0918-SEE CHART

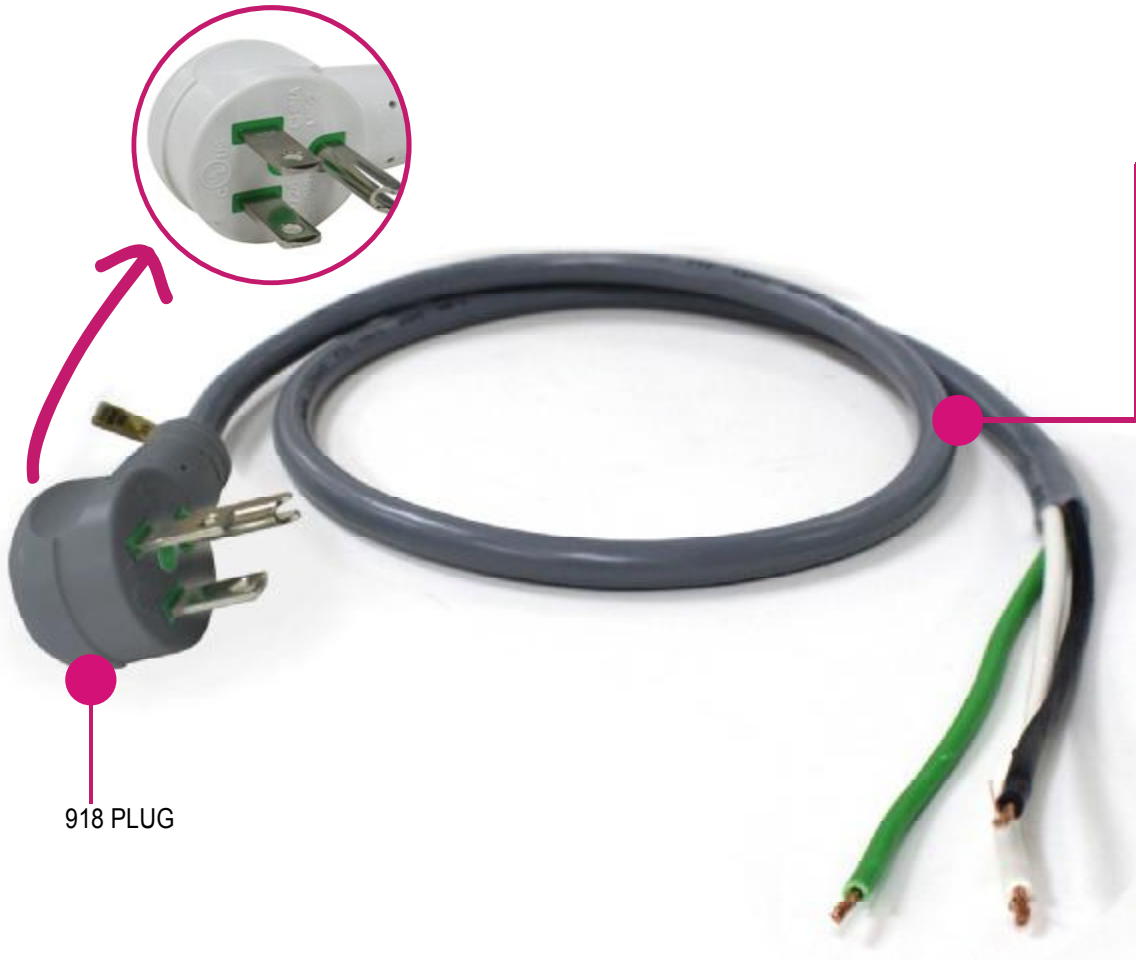

918 PLUG

- ★ Hospital Grade Power Cord Gray, SJT, 5-15P to 5-15R,
- ★ 14/3AWG
- ★ 15A

Hospital Grade Power Cord

FW-0918-SEE CHART

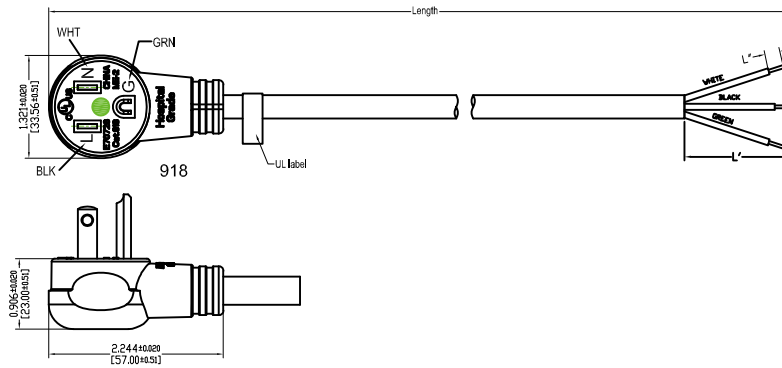

Part No.	Length	Type of Cable	Color of Cable	Color of Male	L' (Black)	L' (White)	L' (Green)	L" (Black)	L" (White)	L" (Green)	Remarks
-001	6.5' ± 1.5"	SJT 14/3 75°C	White	White	95mm	95mm	95mm	8mm	8mm	8mm	15A
-002	10.5' ± 2"	SJT 14/3 75°C	White	White	95mm	95mm	95mm	8mm	8mm	8mm	15A
-003	15.5' ± 2"	SJT 14/3 75°C	White	White	95mm	95mm	95mm	8mm	8mm	8mm	15A

Notes:

1. Products are UL/cUL approved in NEMA WD-6 configurations under file E70726.
2. Multiway cable UL file number is E173957.
3. MM dimensions shown in brackets are for reference only.
4. ● Symbol for Hospital Grade extension cord.

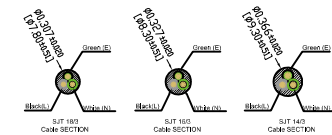

Packaging:

