

Multiway Ind (HK), Ltd.



Lee



Item	Model#	Safety Listed	Photo	Description
FA-749P	FA-749P115 FA-749P515 FA-749P520 FA-749P615 FA-749P620	cULus		15A/20A 125V attachment plug 15A/20A 250V attachment plug Nema: 1-15,5-15,5-20,6-15,6-20. Wire sizes : AWG# 18 to AWG# 14 For 1-15P Wire sizes : AWG# 16 to AWG# 12 For 5-15P,5-20P,6-15P,6-20P
FA-749R	FA-749R115 FA-749R515 FA-749R520 FA-749R615 FA-749R620	UL		15A/20A 125V attachment receptacle 15A/20A 250V attachment receptacle Nema: 1-15,5-15,5-20,6-15,6-20. Wire sizes : AWG# 18 to AWG# 14 For 1-15R Wire sizes : AWG# 16 to AWG# 12 For 5-15R,5-20R,6-15R,6-20R
FA-750P	FA-750P115 FA-750P515 FA-750P520 FA-750P615 FA-750P620	cULus		15A/20A 125V attachment plug Armored housing automatically grounded. Nema: 1-15,5-15,5-20,6-15,6-20. For wire sizes : AWG# 18 to AWG# 12
FA-750R	FA-750R115 FA-750R515 FA-750R520 FA-750R615 FA-750R620	cULus		15A/20A 125V attachment receptacle Armored housing automatically grounded. Nema: 1-15,5-15,5-20,6-15,6-20. For wire sizes : AWG# 18 to AWG# 12
FA-751P	FA-751P1430 FA-751P1450 FA-751P1050 FA-751P1030 FA-751P630 FA-751P650 FA-751P63050	cULus		# FA-751P series for 30/50 amp 125/250V. SRDT AWG#10-6, 3 wire & 4 wire. Dual Voltage selection available :- FA-751P63050 Good for Nema 6-30 / 6-50P FA-751P103050 Good for Nema 10-30 / 10-50P FA-751P143050 Good for Nema 14-30 / 14-50P
FA-752P	FA-752P115 FA-752P515 FA-752P520 FA-752P615 FA-752P620	cULus		15A/20A 125V attachment plug Nema: 1-15,5-15,5-20,6-15,6-20. For wire sizes : SJT AWG# 16 to AWG# 12 FA-752P515 is Hospital Grade attachment plug
FA-752PL	FA-752PL515 FA-752PL520 FA-752PL620	cULus		15A/20A 125V Locking tape attachment plug Nema configurations L5-15PL, L5-20. For wire sizes : SJT,ST AWG# 16 to AWG# 12
FA-752R	FA-752R115 FA-752R515 FA-752R520 FA-752R615 FA-752R620	cULus		15A/20A 125V attachment receptacle Nema: 1-15,5-15,5-20,6-15,6-20. For wire sizes : SJT AWG# 16 to AWG# 12
FA-753P	FA-753P115 FA-753P515 FA-753P520 FA-753P615 FA-753P620	cULus		15A/20A 125V attachment plug Nema: 1-15,5-15,5-20,6-15,6-20. For wire sizes : SJT AWG# 18 to AWG# 12

FA-753R	FA-753R115 FA-753R515 FA-753R520 FA-753R615 FA-753R620	cULus		15A/20A 125V attachment receptacle Nema: 1-15,5-15,5-20,6-15,6-20. For wire sizes : SJT AWG# 18 to AWG# 12
FA-754P	FA-754PTT	cULus		30A 125V TRAILER PLUG Cat.No:FA-754P attachment plugs for RV Nema configurations TT(SB0993) For wire sizes : SJT,ST AWG#10 to AWG# 8
FA-756 RV adapter	FA-756RV	Non UL		15A/30A 125V TRAILER ADAPTER Nema configurations 5-15P to TT(SB0993)
FA-756A RV adapter	FA-756ARV	Non UL		15A/30A 125V TRAILER ADAPTER Nema configurations TT(SB0993) to 5-15R
FA-757P	FA-757PL530 FA-757PL630	cULus		30A 125V Locking type attachment plug
FA-760P	FA-760P515	cULus		15A 125V attachment plug Good for SPT & SJT AWG# 18 to AWG# 14
FA-760R	FA-760R515	cULus		15A 125V attachment receptacle Good for SPT & SJT AWG# 18 to AWG# 14
FA-761P	FA-761P115	cULus		15A 125V attachment plug Good for SPT & SJT AWG# 18 to AWG# 14
FA-761R	FA-761R115	cULus		15A 125V attachment receptacle Good for SPT & SJT AWG# 18 to AWG# 14

For Enquiry, please do contact :-

Multiway Ind (HK) Ltd., Unit 5B, 7th floor, Taxaco Road Ind Centre, 14-22 Wang Lung Street,
Tsuen Wan, Hong Kong, SAR China. Phone : (852) 2407 5405 Fax : (852) 2407 6236

Email : Sales@Multiway.com



FA-749P Series

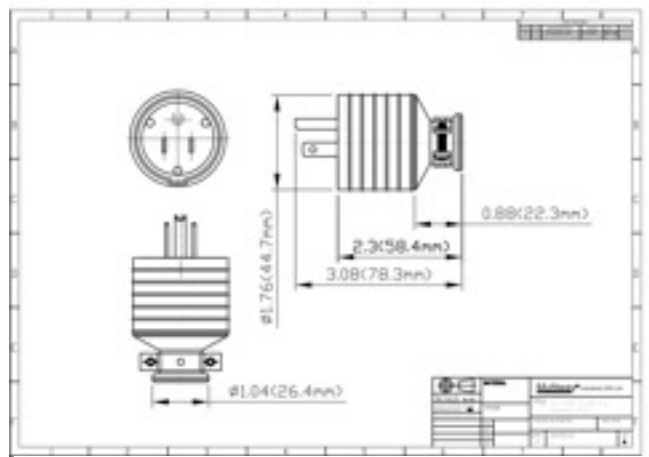

FA-749R Series

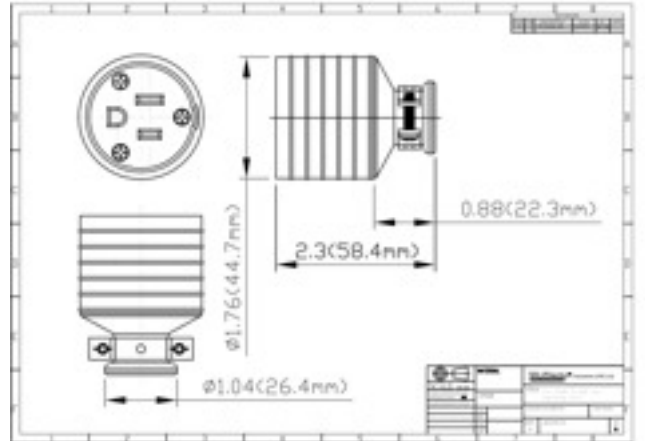

FA-750P Series Metal Shield Grounded

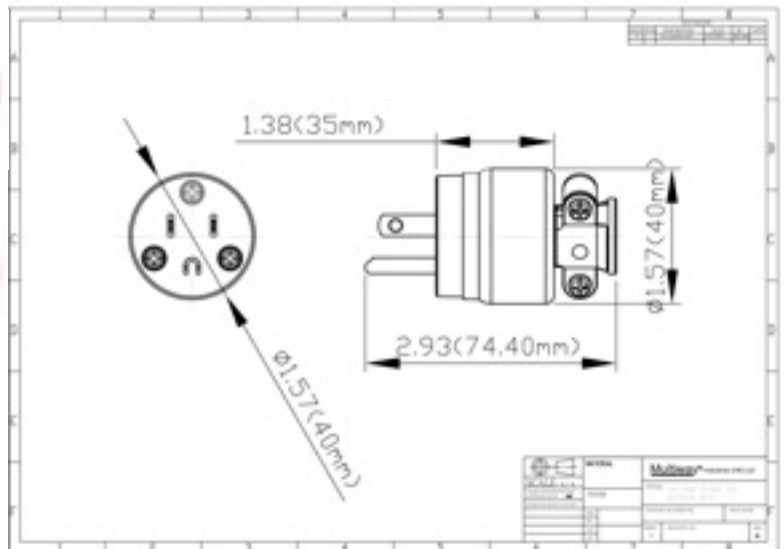

FA-750P Series Metal Shield Grounded

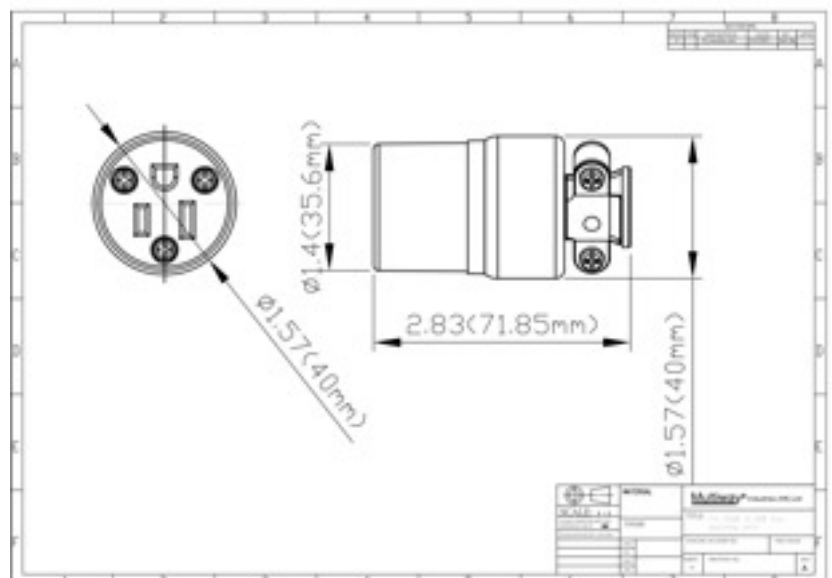



FA-751P

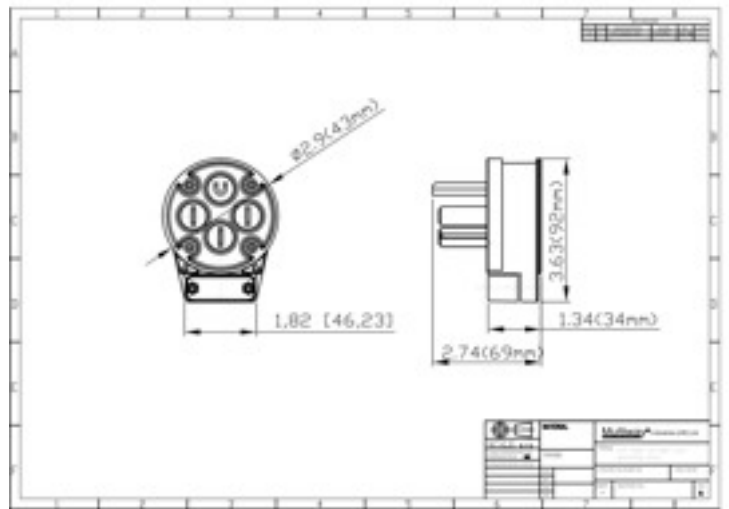

FA-752P & FA-752PL



Hospital Grade
Approved

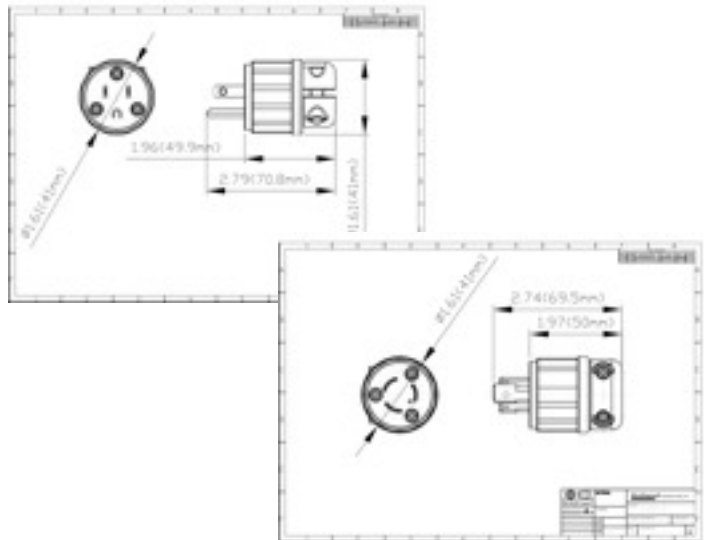

FA-752R

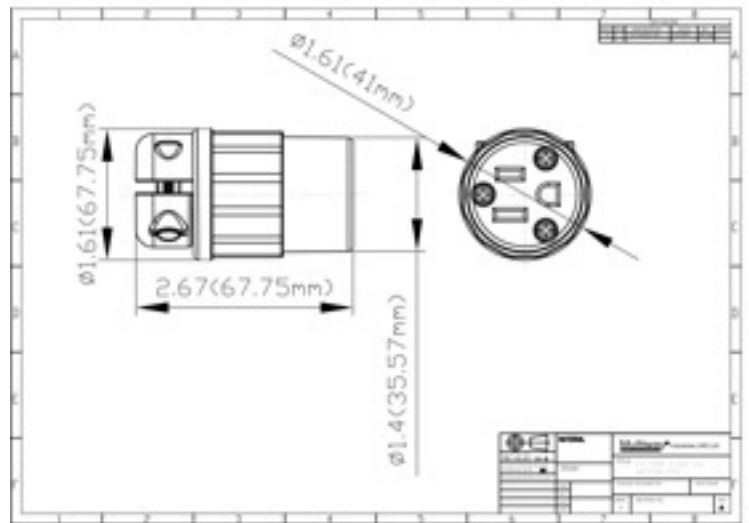

FA-753P

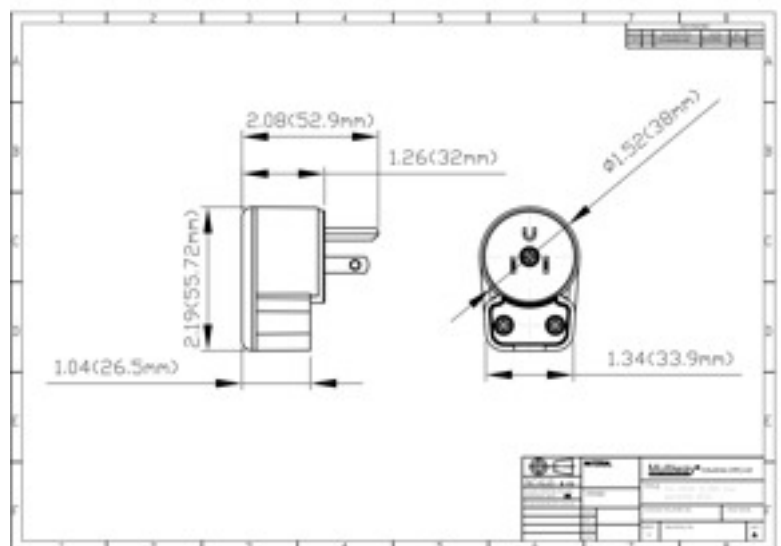



FA-753R

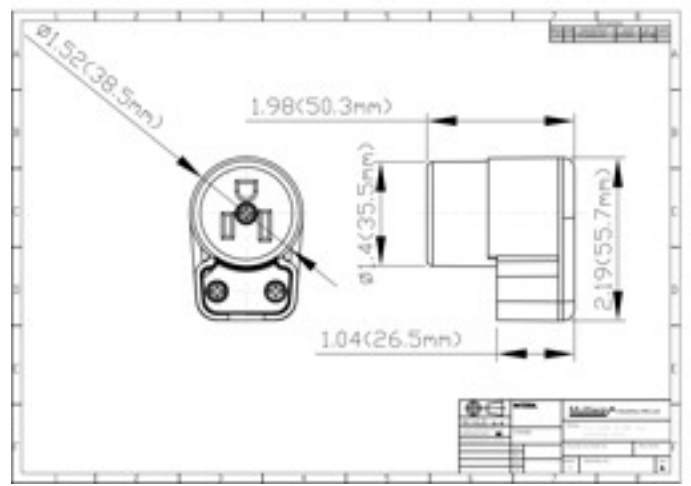

FA-754P

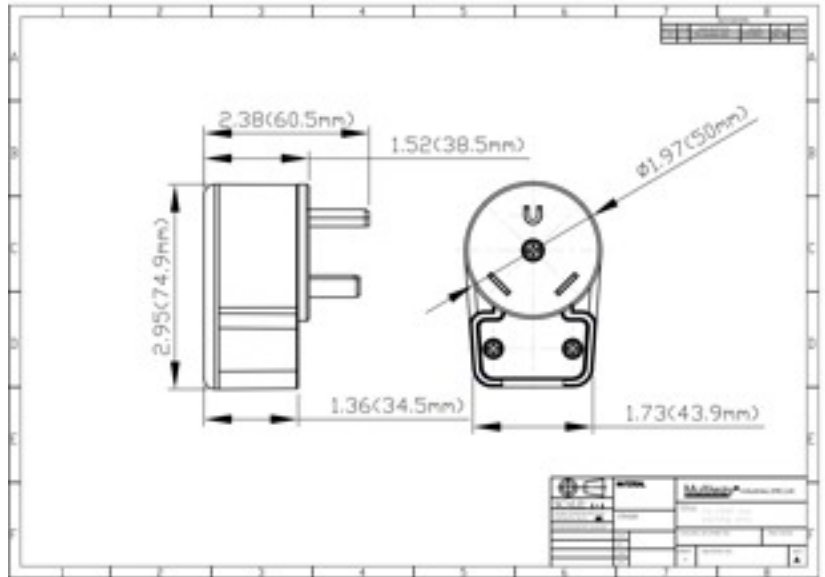

FA-756RV

Non-UL certified but made to UL standards

FA-756ARV

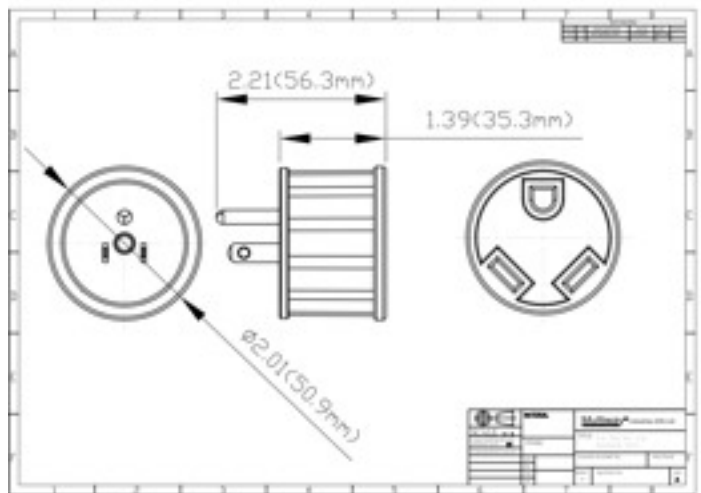

Non-UL certified but made to UL standards

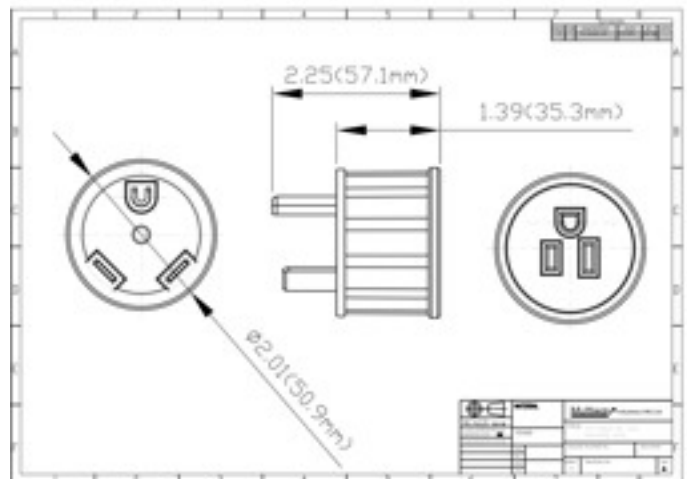



FA-757P

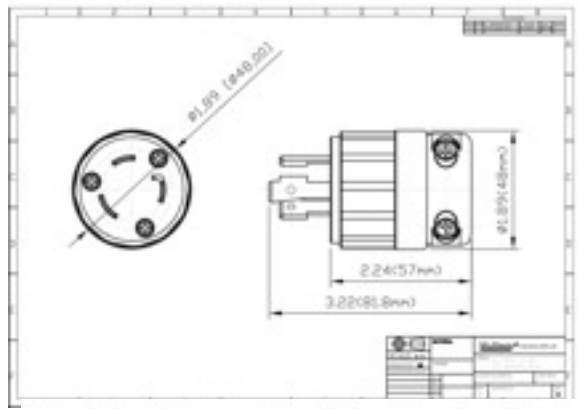

FA-760P

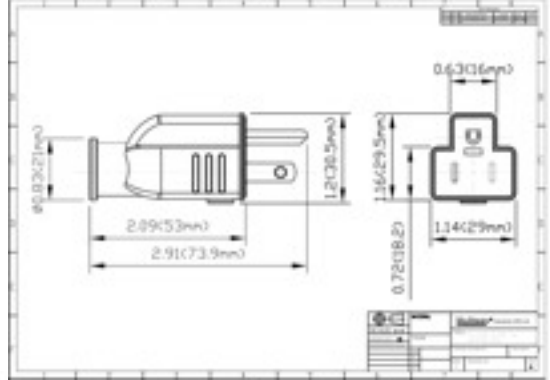

FA-760R

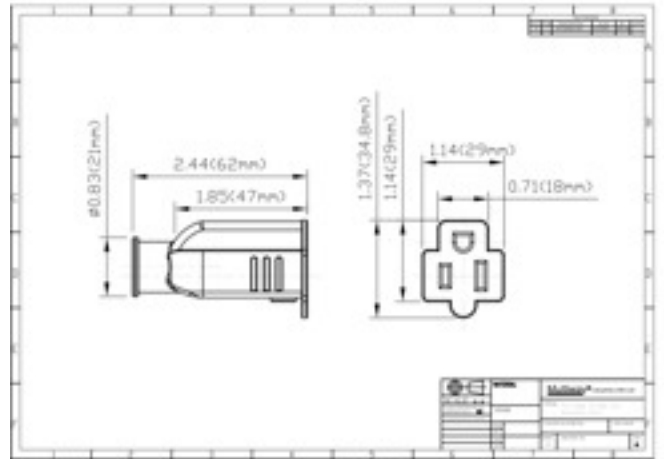

FA-761P

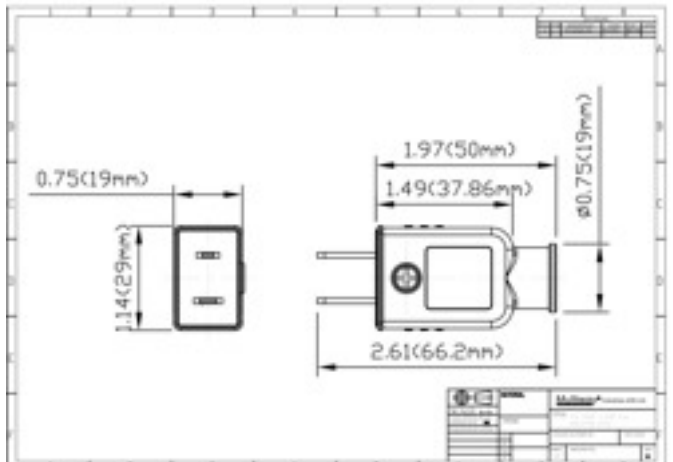

FA-761R

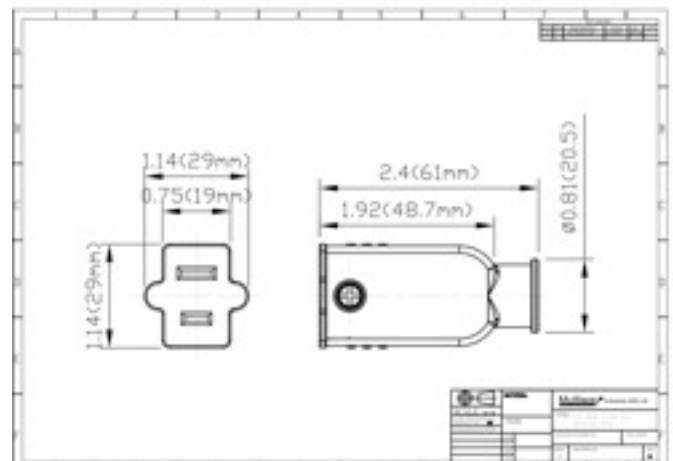

UL / cUL Certificate



AXUT.E175116 Attachment Plugs, Fuseless

[Page Bottom](#)

Attachment Plugs, Fuseless

[See General Information for Attachment Plugs, Fuseless](#)

MULTIWAY INDUSTRIES (HK) LTD

E175116

7TH FL, UNIT 5
TEXACO RD INDUSTRIAL CENTRE
14-22 WANG LUNG ST, BLK B
TSUEN WAN, HONG KONG

Trademark and/or Tradename: "ME-2"

Adapters, Cat. Nos. D7510-96-86, D7510-96-86, FF-498, GE4391#, GE4391A#, GE4392, 045A, 310-1-C, 312A, 312AL, 313A, 313AL, FA-115.

Attachment plugs, Series FA-749P.

Series FA-751P, FA-757P.

Cat. No. FA-754P.

Series FA-750P, FA-752P and FA-753P.

Models FA-760P(5-15P) and FA-761P(1-15P).

Cord connectors, Type FA-749R.

Series FA-750R, FA-752R and FA-753R.

Model FA-758R(5-15R).

Models FA-760R(5-15R) and FA-761R(1-15R).

- May be followed by alphanumeric suffixes up to seven places to indicate color and packaging variations.

[Last Updated](#) on 2012-07-25

[Questions?](#)

[Print this page](#)

[Terms of Use](#)

[Page Top](#)

© 2012 UL LLC

When the UL Leaf Mark is on the product, or when the word "Environment" is included in the UL Mark, please search the [UL Environment database](#) for additional information regarding this product's certification.

The appearance of a company's name or product in this database does not in itself assure that products so identified have been manufactured under UL's Follow-Up Service. Only those products bearing the UL Mark should be considered to be Listed and covered under UL's Follow-Up Service. Always look for the Mark on the product.

UL permits the reproduction of the material contained in the Online Certification Directory subject to the following conditions: 1. The Guide Information, Designs and/or Listings (files) must be presented in their entirety and in a non-misleading manner, without any manipulation of the data (or drawings). 2. The statement "Reprinted from the Online Certifications Directory with permission from UL" must appear adjacent to the extracted material. In addition, the reprinted material must include a copyright notice in the following format: "© 2012 UL LLC".



AXUT7.E175116 Attachment Plugs, Fuseless Certified for Canada

[Page Bottom](#)

Attachment Plugs, Fuseless Certified for Canada

[See General Information for Attachment Plugs, Fuseless Certified for Canada](#)

MULTIWAY INDUSTRIES (HK) LTD

E175116

7TH FL, UNIT 5
TEXACO RD INDUSTRIAL CENTRE
14-22 WANG LUNG ST, BLK B
TSUEN WAN, HONG KONG

Appliance couplers

Cat. No.	No. Poles	No. Wire	Rating	Note
FA-115	2	2	15A, 125V	—

Attachment plugs

Cat. No.	No. Poles	No. Wire	Rating	Note
FA-749 1-15P	2	2	15A, 125V	2
FA-749 5-15P	2	3	15A, 125V	2
FA-749 5-20P	2	3	20A, 125V	2
FA-749 6-15P	2	3	15A, 250V	2
FA-749 6-20P	2	3	20A, 250V	2
FA-751P(10-30P)	3	3	30 A, 125/250 V	2
FA-751P(10-50P)	3	3	50 A, 125/250 V	2
FA-751P(14-30P)	3	4	30 A, 125/250 V	2
FA-751P(14-50P)	3	4	50 A, 125/250 V	2
FA-751P(6-30P)	2	3	30 A, 250 V	2
FA-751P(6-50p)	2	3	50 A, 250 V	2
FA-754P	2	3	30 A, 120 V	2
FA-757P(L5-30P)	2	3	30 A, 125 V	2
FA-757P(L6-30P)	2	3	30 A, 250 V	2
FA-750P(1-15P)	2	2	15A, 125V	2
FA-750P(5-15P)	2	3	15A, 125V	2
FA-750P(5-20P)	2	3	20A, 125V	2
FA-750P(6-15P)	2	3	15A, 250V	2
FA-750P(6-20P)	2	3	20A, 250V	2
FA-752P(1-15P)	2	2	15A, 125V	2
FA-752P(5-15P)	2	3	15A, 125V	1
FA-752P(5-20P)	2	3	20A, 125V	2
FA-752P(6-15P)	2	3	15A, 250V	2

FA-752P(6-20P)	2	3	20A, 250V	2
FA-752P(L5-15P)	2	3	15A, 125V	2
FA-752P(L5-20P)	2	3	20A, 125V	2
FA-752P(L6-20P)	2	3	20A, 250V	2
FA-753P(1-15P)	2	2	15A, 125V	2
FA-753P(5-15P)	2	3	15A, 125V	2
FA-753P(5-20P)	2	3	20A, 125V	2
FA-753P(6-15P)	2	3	15A, 250V	2
FA-753P(6-20P)	2	3	20A, 250V	2
FA-760P(5-15P)	2	3	15A, 125V	2
FA-761P(1-15P)	2	2	15A, 125V	2

Cord connectors

Cat. No.	No. Poles	No. Wire	Rating	Note
FA-750R(1-15R)	2	2	15A, 125V	2
FA-750R(5-15R)	2	3	15A, 125V	2
FA-750R(5-20R)	2	3	20A, 125V	2
FA-750R(6-15R)	2	3	15A, 250V	2
FA-750R(6-20R)	2	3	20A, 250V	2
FA-752R(1-15R)	2	2	15A, 125V	2
FA-752R(5-15R)	2	3	15A, 125V	2
FA-752R(5-20R)	2	3	20A, 125V	2
FA-752R(6-15R)	2	3	15A, 250V	2
FA-752R(6-20R)	2	3	20A, 250V	2
FA-753R(1-15R)	2	2	15A, 125V	2
FA-753R(5-15R)	2	3	15A, 125V	2
FA-753R(5-20R)	2	3	20A, 125V	2
FA-753R(6-15R)	2	3	15A, 250V	2
FA-753R(6-20R)	2	3	20A, 250V	2
FA-758R(5-15R)	2	3	15A, 125V	2
FA-760R(5-15R)	2	3	15A, 125V	2
FA-761R(1-15R)	2	2	15A, 125V	2

Notes:

1. Hospital grade
2. Appliance type

Last Updated on 2012-07-25

[Questions?](#)

[Print this page](#)

[Terms of Use](#)

[Page Top](#)

© 2012 UL LLC

When the UL Leaf Mark is on the product, or when the word "Environment" is included in the UL Mark, please search the [UL Environment database](#) for additional information regarding this product's certification.

The appearance of a company's name or product in this database does not in itself assure that products so identified have been manufactured under UL's Follow-Up Service. Only those products bearing the UL Mark should be considered to be Listed and covered under UL's Follow-Up Service. Always look for the Mark on the product.